

**EWT100**  
**WIRE TO WIRELESS TRANSLATOR MODULE**  
**FIREVIBES SERIES**



**User instructions manual**

## GENERAL DESCRIPTION

The **EW100** permits to integrate a **FireVibes** wireless network to an intelligent fire security installation. This solution is useful in environments where a wired installation would be difficult, inconvenient or problematic.

The **EW100** has to be connected to the intelligent control panel's loop and the new wireless devices have to be programmed / acquired into panel's view; done so, the panel will have the capability to detect fire alarms in the area protected by the wireless system, and, in general, the capability of controlling the wireless devices of the FireVibes system.

**EW100** has to be powered either by:

- an EN 54-4 certified external power supply source or
- the intelligent loop.

**EW100B** is a black version of **EW100**. All pictures showing in this manual the white version, are also valid for the black version.

## CONTROL PANEL COMPATIBILITY

Check the compatibility of the intelligent control panel:

- **EW100** requires the intelligent Inim Loop protocol;
- control panel's features and technical specifications ranges and values have to be suitable for the **EW100**.

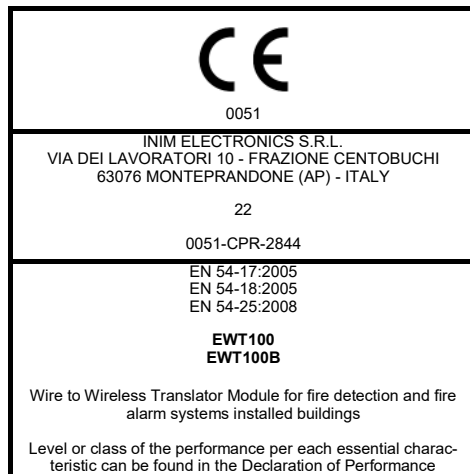

## WARNINGS AND LIMITATIONS

Our devices use high quality electronic components and plastic materials that are highly resistant to environmental deterioration. However, after 10 years of continuous operation, it is advisable to replace the devices in order to minimize the risk of reduced performance caused by external factors.

Ensure that this device is only used with compatible control panels.

Detection systems must be checked, serviced and maintained on a regular basis to confirm correct operation.

Smoke sensors may respond differently to various kinds of smoke particles, thus application advice should be sought for special risks.

Sensors cannot respond correctly if barriers exist between them and the fire location and may be affected by special environmental conditions.

Refer to and follow national codes of practice and other internationally recognized fire engineering standards.

Appropriate risk assessment should be carried out initially to determine correct design criteria and updated periodically.

Use only in FireVibes fire detection and alarm systems.

## WARRANTY

All devices are supplied with the benefit of a limited 5 years warranty relating to faulty materials or manufacturing defects, effective from the production date indicated on each product.

This warranty is invalidated by mechanical or electrical damage caused in the field by incorrect handling or usage.

Product must be returned via your authorized supplier for repair or replacement together with full information on any problem identified.

Full details on our warranty and product's returns policy can be obtained upon request.

## CORRECT DEVICE POSITIONING

- Apply mandatory codes of practice and standards of your country.
- Use wireless channels that are free or reasonably free from other interfering signals; possibly avoid using channels that are already used by other systems.
- Don't install wireless devices in the vicinity of equipment using large amounts of electrical current.
- Don't install wireless devices in the vicinity of large metal objects, structures or metal ceiling structures.
- Don't install wireless devices in the vicinity of fluorescent light fixings.
- Don't install wireless devices in the vicinity of computers, their cabling and their network cabling.
- Wireless devices, in their final installation location, must have a minimum distance of at least 2 meters between each other.
- Install central and expander network nodes at an height of at least 2 - 2.5 meters from the floor.
- Fix central and expander network nodes flat on the wall.
- Environmental temperature and humidity must lay in the ranges specified in the technical specifications at the beginning of this manual. Environmental compatibility applies to all devices in general.
- Environmental conditions must be withstandable by the installed devices. Check the device's IP rating adequacy with the installation's environmental characteristics; IP rating value is found in the technical specifications at the beginning of this manual. Environmental compatibility applies to all devices in general.
- Make sure that all child devices (in their final installation location) are reached by good strong wireless signals from their father nodes (central and expander ones).
- Make sure that all father nodes (central and expander ones, in their final installation location) are reached by good strong wireless signals from their child devices.
- Make sure that all network nodes (central and expander ones, in their final installation location) are reached by good strong wireless signals from their linked-to network nodes.

 It is advisable to use the EWT100-TESTER survey kit to locate a good wireless installa-

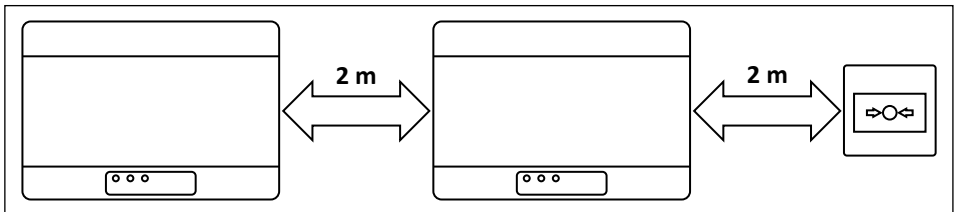

Picture 1

## INSTALLATION

- 1) Remove the two plastic screw covers from the front side.  
Lifting the protective covers using the gaps at their angles makes this operation easier.



Picture 2

2) Remove the four sealing plastic screws.

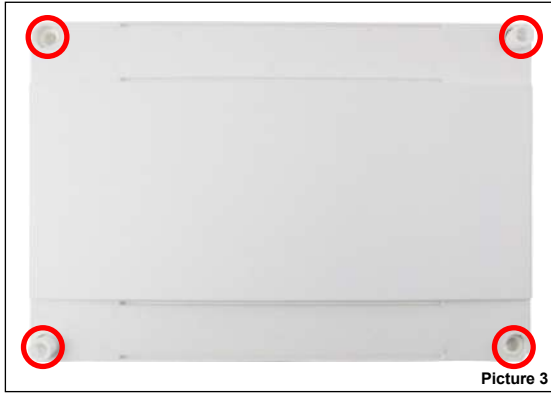

3) Remove the front protective cover.

4) Remove the two holding screws at the base of the printed circuit board.



5) Slide upwards the board and extract it from the box.

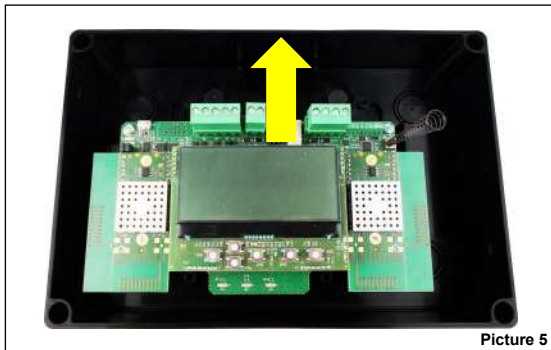

## TECHNICAL SPECIFICATIONS

Specification	Value
Power supply voltage range (from intelligent loop)	from 19 Vdc to 30 Vdc
Power supply voltage range (from external EN 54-4 source)	from 9 Vdc to 40 Vdc
Maximum loop current (device loop powered)	0.5A
Maximum Loop powered EWT100 on a single loop	10 (to be verified with Loop Configurator)
Typical current load	16 mA (27 Vdc)
Wireless frequency band(s) of operation	868-868.6 MHz, 868.7-869.2 MHz, 869.4-869.65 MHz, 869.7-870.0 MHz
RF output power (max)	14 dBm (25 mW) e.r.p.
Number of wireless channels	66
Wireless communication range *	200 m in open space
Maximum number of linked <b>XWT100</b> expander devices	15
Maximum number of linked <b>XWT100</b> expander devices in serial cascade order	8
Maximum number of linked child devices	32
Technical temperature range	from -20 °C to 70 °C
EN 54 approved temperature range	from -10 °C to 55°C
Humidity range without condensing	from 5% RH to 90% RH
Device dimensions	235 mm x 160 mm x 70 mm
Device weight	700 g
Technical IP rating	65
EN 54 approved IP rating	30

Table 1

\* Environmental physical obstacles can reduce this value.

## SHORT CIRCUIT PROTECTION SPECIFICATIONS

Specifications topic	Acronym	Min	Typ	Max	Unit	Notes
Line voltage	-	19	27	30	V	
Maximum rated continuous current with the switch closed	$I_{C\ max}^*$	0.4		0.6	A	
Maximum rated switching current	$I_s\ max^*$	0.4		0.6	A	
Voltage at which the device open	$V_{so}^*$	10.5		11.9	V	
Voltage at which the device reconnects	$V_{sc}^*$	2,95		8,04	V	
Leakage current with the switch open	$I_L^*$			10.91	mA	
Series impedance with the switch closed	$Z_c^*$	0.1		0.223	$\Omega$	
Voltage at which the device isolates	$V_{so}^*$	10		16.5	V	

Table 2

\* Specification refers to EN 54-17 .

- 6) Drill into the wall the required number of holes you need to fix the box. Refer to the following pictures for the distances between the four "IP safe" holes and the distances between the four mould-printed knock-out slots on the rear side of the box. Use the IP safe holes if you want to preserve the original IP rating of the device box, otherwise use the internal knock-out slots, the manufacturer is discharged from the liability following damage to the device that can occur from environmental factors.

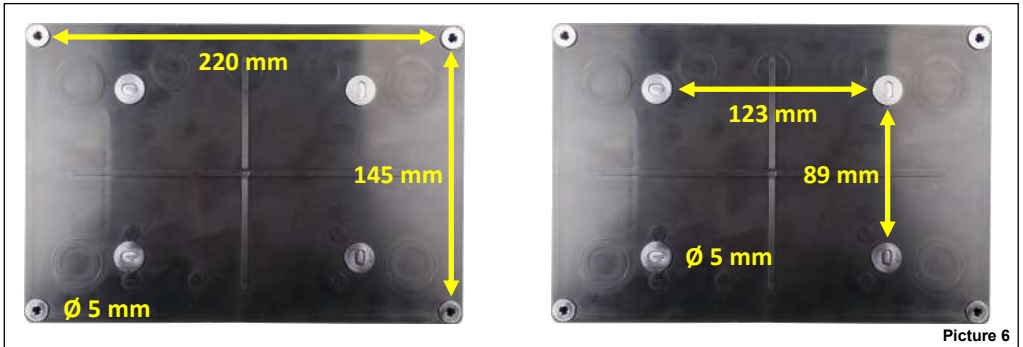

Picture 6

- 7) The box is designed with M16/M20/M25 knock-out holes to provide IP safe compatibility with electrical cable glands. Knock out the required ones. If one or more holes have been opened but remain unused, fill them with suitable IP safe blanking plugs in order to maintain the native ingress protection degree of the box. It is suggested to select external cabling entries that are at a certain distance from the device's antennas. Upper side entries of the box are the best choice.

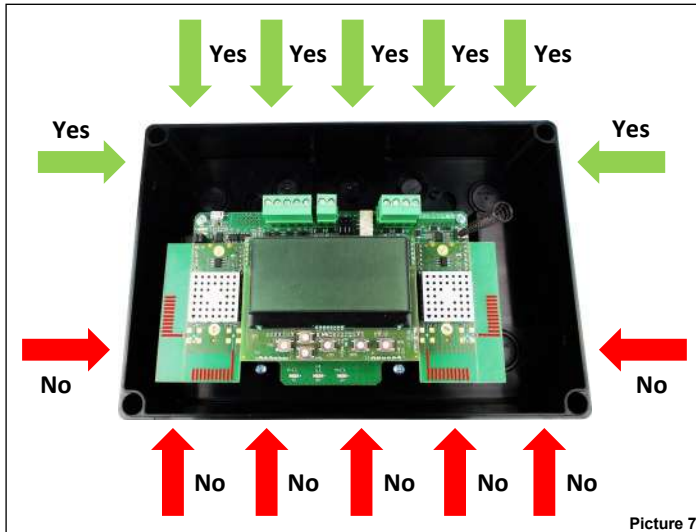

Picture 7

- 8) Install the required cable glands.
- 9) Fix the device box to the wall; use adequate screws and avoid the countersunk type.
- 10) Slide into the box the printed circuit board.
- 11) Fix the board to the box using the two screws you removed before.
- 12) Perform the required wiring.
- 13) Program the device.
- 14) Reinstall the front cover.
- 15) Screw the front cover: fixing has to be IP safe and not loose.
- 16) Reinstall the plastic screw covers.
- 17) Check that your installation is safe, secure and fault-free; perform the functional test.

## WIRING - PRELIMINARY NOTES

- Apply mandatory codes of practice and safety standards of your country.
- This device requires either:
  - a EN 54-4 certified power supply source or
  - to be power supplied directly from the intelligent loop.
- If the **EWT100** is externally powered, allow a maximum cable length of 3 meters between the EN 54-4 power supply source and the device.
- When performing wiring operations, disconnect either the external power supply source or the intelligent loop.
- The printed circuit board is sensitive to electrostatic discharges: take suitable precautions when handling it in order to avoid damage.
- Connect the wire terminals to their correct blocks on the printed circuit board; keep this manual handy as a reference for good connection implementation.
- Safely screw the wire terminals to their corresponding blocks.
- Avoid mechanically loose or weak connections.
- Avoid accidental shorts between terminals.
- Allow sufficient wire length into the device box so you can comfortably screw the terminals to their corresponding blocks; this is also important to avoid mechanical stress on terminal-block couplings.



The external power input is not isolated and its negative terminal is directly connected to the device internal reference. The external power supply must provide the needed isolation to avoid panel earth fault and to guarantee the correct behaviour of isolators.



The printed circuit board is sensitive to electrostatic discharges: take suitable precautions when handling it in order to avoid damage.

## TRANSLATOR BACKUP BATTERY

Ensure the Translator Backup Battery is correctly installed on the Translator. The Translator Backup Battery has to be inserted to preserve the Time clock and Date when the Translator is not powered by loop or external PSU. Moreover, the Translator Backup Battery is needed also in order to use the auto-address procedure on Fire Control Panel.

The Translator Backup Battery is located on the rear of the translator board. Make sure to insert the battery with the correct polarity; positive pole up.

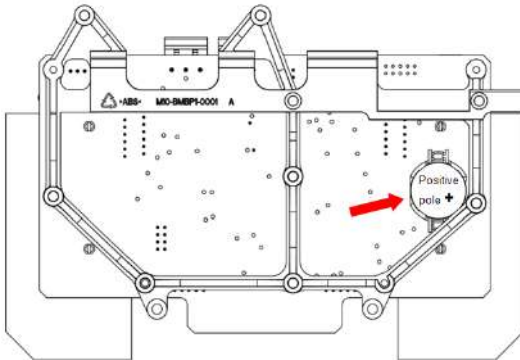

Battery Specification	Value
Battery type	CR2032 Lithium Battery

## TERMINAL BLOCKS LOCATION

Terminal blocks are located on the printed circuit board in the positions highlighted in the following picture:

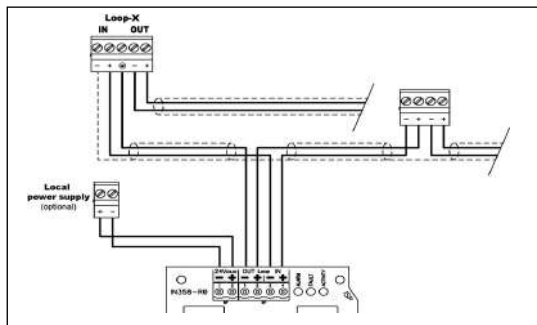

Picture 8

## EWT100 WIRING PROCEDURE - POWER SUPPLY FROM LOOP

- 1) Connect the loop terminals (Connector 1-2, LOOP Interface IN/OUT)

## EWT100 WIRING PROCEDURE - EN 54-4 EXTERNAL POWER SUPPLY

- 1) Connect the power supply terminals (Connector 3, External Power Supply)
- 2) Connect the loop terminals (Connector 1, LOOP Interface IN)

## RADIO DEVICE ADDRESSING MANAGEMENT

Each device from FireVibes series is identified by 2 different addresses:

- **FireVibes address:** device address assigned from EWT100 translator and used for the wireless communications;
- **Inim loop address:** device analog address assigned from Inim control panel and used for communications on the loop.

The EWT100 translator creates a virtual copy of the wireless device and makes it available on the Inim loop; for this purpose, to each wireless device will be assigned a virtual address (e.g. 010EACDD), according to the following convention:

# AABBCC-XX

- The prefix "AABBCC" is the identifier of the EWT100 which a FireVibes wireless device is associated to and this identifier is defined by factory default. Each EWT100 has "AABBCC81" address.
- The postfix "XX" is the FireVibes device address, used on the EWT100 display and for the FireVibes software communications.

EWT100 connection with the Inim control panel follows the rules of the Enea series devices.

Each EWT100 translator can enroll up to 127 FireVibes devices. So the maximum number of addresses is 128, including the EWT100 address.

There is no limit for the number of EWT100 connected on the loop; anyway the sum of addressed devices (including both wireless FireVibes and wired Enea devices) must be a maximum of 240.

Here following an example of Enea/FireVibes loop:

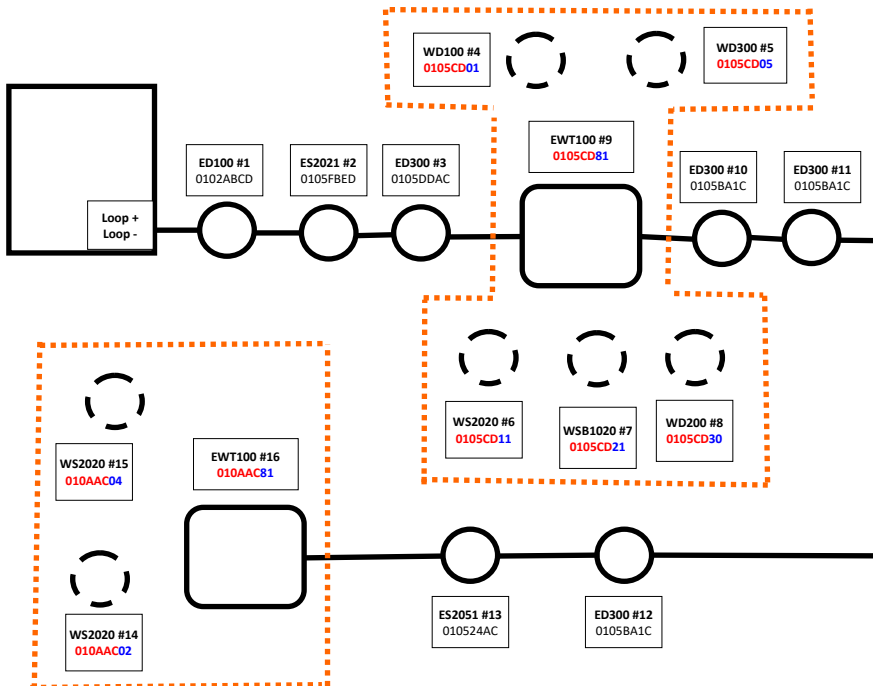

FireVibes devices are virtually located in the topology map as if physically connected in series and in order of the FireVibes wireless address.



**WIRING - POWER SUPPLY'S TERMINAL BLOCKS LAYOUT**

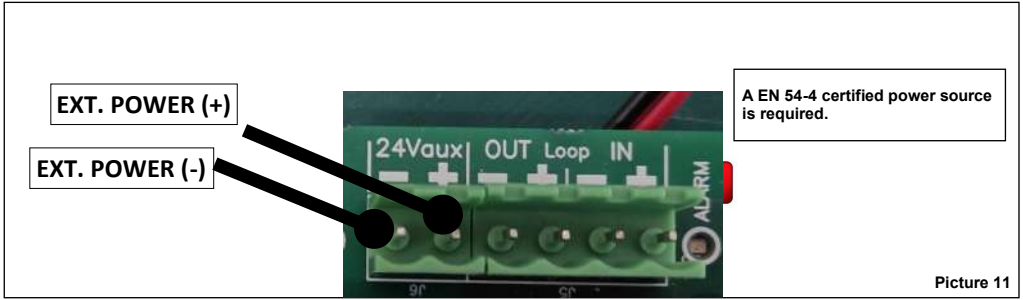

Picture 11

Block	Description	Note
EXT. POWER (-)	Power supply, negative pole	EN 54-4 certified power source is required
EXT. POWER (+)	Power supply, positive pole	EN 54-4 certified power source is required

Table 3

## WIRING - INIM LOOP - TERMINAL BLOCKS LAYOUT

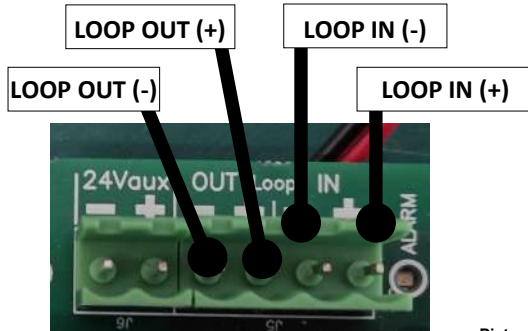

Picture 13

Block	Description	Note
LOOP IN (-)	Loop negative input	Short circuit protected
LOOP OUT (-)	Loop negative output	
LOOP IN (+)	Loop positive input	
LOOP OUT (+)	Loop positive output	

Table 5

## THE PURPOSES OF PROGRAMMING

Programming is done for the following purposes:

- activating or deactivating the signalling of power supply's fault events;
- activating or deactivating the signalling of tamper events;
- integrating the **EWT100** into the wireless system; this means creating a wireless exclusive direct link with **EWT100** expanders;
- creating wireless exclusive links with local child devices (detectors, call point, sounders.....).

## PROGRAMMING SETUP PROCEDURE

- 1) Install on your personal computer the Inim **FireVibes** software.
- 2) Connect your personal computer to the printed circuit board; for this operation a standard-to-micro USB cable is used; micro USB socket location is highlighted in the picture below:

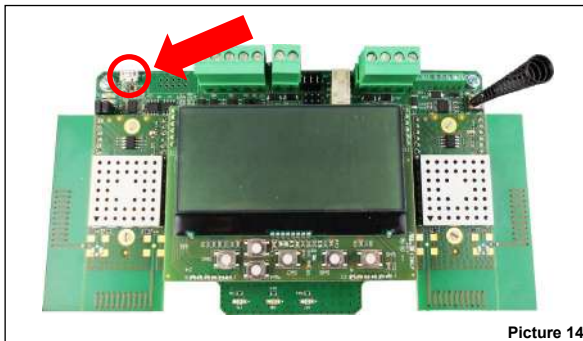

Picture 14

- 3) Make sure the device is powered up.

## PROGRAMMING

For more data about programming this device refer to the following documentation:

- the **FireVibes** software manual;
- the user instructions manuals of the FireVibes series' products.

## THE USER'S KEYPAD AND DISPLAY

The device keypad and display system is used for two basic purposes:

- Diagnose the **EWT100** and the system: check event occurrences, faults, settings, etc.
- Program device and system's settings.

Keypad and display system is the manual alternative to the use of the **FireVibes** configuration software.

## THE USER'S KEYPAD

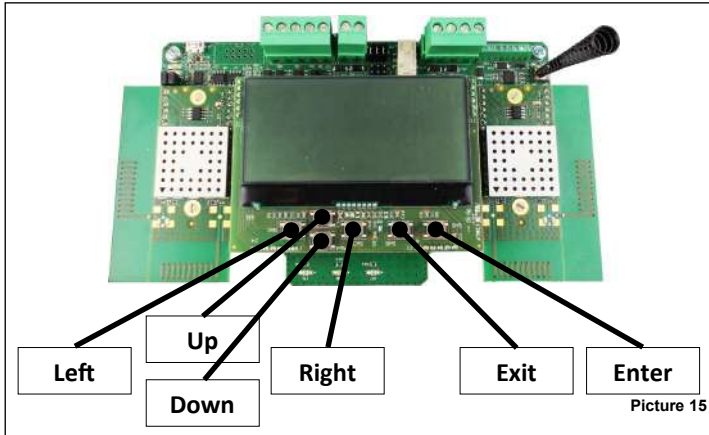

Keypad buttons are:

- Up** Pulls up the display's menu selection.  
If applied to a value, the selected digit is increased.
- Down** Pushes down the display's menu selection.  
If applied to a value, the selected digit is decreased.
- Left** Returns to the previous menu.  
If editing a value, sets the cursor to the left digit.
- Right** Enters into the next submenu.  
Some options require exclusively the "Enter" key to gain access to the next submenu.  
If editing a value, sets the cursor to the right digit.
- Enter** Enters into the next submenu.  
Confirms the selected setting.
- Exit** Returns to the previous menu.

## THE USER'S DISPLAY

In a normal and eventless condition the display will have picture 16's lookalike.

- EWT100** Indicates that this device is a **EWT100**.
- Sys: 038** Indicates the number that identifies the FireVibes wireless system (system code); in this case 038.
- N: 09/45** "Network" channels; system-wide wireless network numbered channels that are used by the **EWT100** to exchange data with the expanders; in this case channel 9 and channel 45.
- F: 55/25** "Field" channels; local wireless network numbered channels that are used by the **EWT100** to exchange data with local child devices; in this case channel 55 and channel 25.

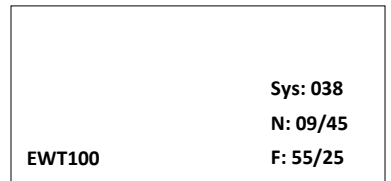

Of the main window, displayed data has the following meaning:

## **THE DISCOVERY OPERATION**

The discovery of all possible routes for the wireless messages travelling throughout the system is called "discovery".

The discovery operation concerns only the network devices (**XWT100**) and not the child devices.

Discovery is performed only once at the beginning, during the installation phase. It can be performed successively (e.g. following environmental changes) in order to redefine the best messaging routes for the system.

Discovery procedure:

- 1) Set all **EWT100/XWT100** system's devices in "Discovery mode".  
This operation is accomplished only through the **EWT100**'s keypad / display system.  
See the **EWT100**'s manual for precise instructions.
- 2) Trigger and complete the discovery operation from **FireVibes STUDIO**.  
See **FireVibes STUDIO** manual.

## **EVENT SIGNALLING**

Wireless system's events, like faults and alarms, are notified to the user in both of the following ways:

- through specific LEDs, visible even if the printed circuit board is hidden by the front cover:
  - Yellow LED: Fault condition on EWT100 or on a child radio device;
  - Red LED: Alarm condition
- through written messages visualized on the LCD display; the LCD is visible only if the front cover is not installed.



**EWT100's user interface and FireVibes software will prompt you whether to use channel A, B or C for discovery. Use the less congested / relatively free channel: if channel A gives problems use B; if B gives problems use C.**

**(Preferably, use the EWT100-TESTER survey kit to diagnose channel A, B and C.)**

**Make sure you specify the same channel on the EWT100 and FireVibes Software.**



**EWT100 does not require any particular keypad / display operation for the discovery operation.**

**LED SIGNALS - DEVICE IS POWERED ON**

The blinking green LED above the "Power" icon indicates that the device is switched on.



Picture 18

**LED SIGNALS - ALARM**

The red LED above the "Flame" icon indicates that an alarm event has occurred.



Picture 19

**LED SIGNALS - FAULT**

The yellow LED above the "Spanner" icon indicates that a fault event has occurred.



Picture 20

## TAMPER DETECTION

**EW100** is equipped with a tamper detection switch; when the front cover is removed, the switch-spring system is released, causing a tamper event message to be routed to the control panel.

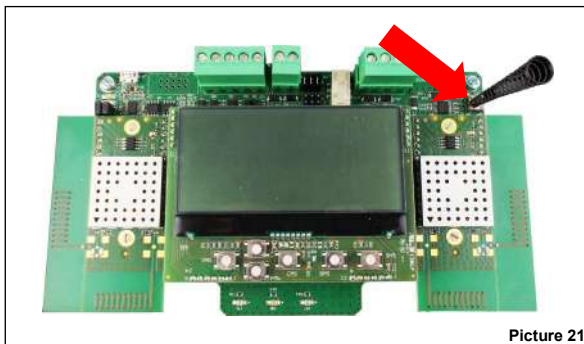

Picture 21

Tamper detection capability can be disabled / enabled from **FireVibes**



**EN 54 requires you to keep tamper detection enabled.**

## ONBOARD DISPLAY'S EVENT SIGNALLING

Event occurrences are notified on the **EW100**'s onboard display as in the following example:

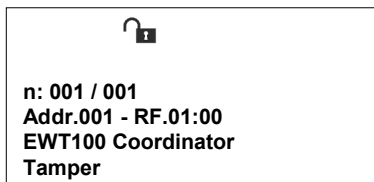

Picture 22

Where: **n:** The "n." row indicates the number of the message event and the total of the messages available for viewing. To go through the message events use the left / right and up / down keys.

### Addr. - RF

This row indicates the address of the device "affected" by the event. "Addr." is the analogue address as seen by the wired control panel. "RF" is the wireless address which is a composed by the network device address (**EW100**'s, **XW100**'s) and the child device address (if "0" refers to the network device itself).

### FireVibes Coordinator

In this example it is the generic description of the **EW100**.

### Tamper

In this example it is a "tamper" detection event type.

During event signalling icons are also displayed, carrying the following meanings:

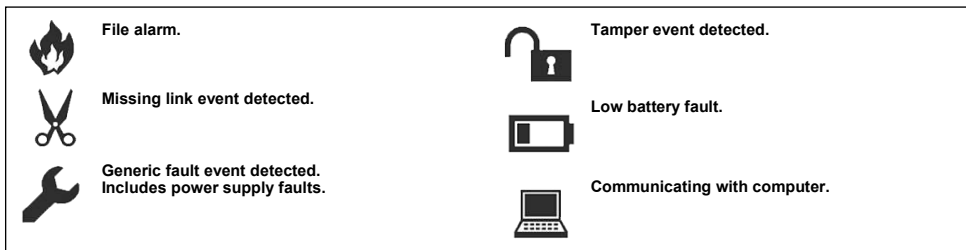

Picture 23

### **FUNCTIONAL TEST - ALARM TESTING**

Test the **EWT100**'s alarm signalling capability as follows:

- 1) Activate an alarm on the FireVibes system.
- 2) Check that the **EWT100** locally displays the alarm event.
- 3) Check that the control panel displays the alarm event.
- 4) Check that FireVibes and intelligent output child devices activate (e.g. sounders...).
- 5) Reset all system from the control panel.

### **FUNCTIONAL TEST - FAULT TESTING**

Test the **EWT100**'s fault signalling capability as follows:

- 1) Activate a fault event.
- 2) Check that the **EWT100** locally displays the fault event.
- 3) Check that the control panel displays and notifies the fault event.
- 4) Reset all the system from the control panel.



**Apply mandatory testing and periodic testing policies of your country.**

---

**NETWORK DEVICE QR CODE**

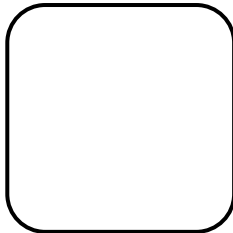

---

NOTE

**FIELD DEVICES QR CODE**

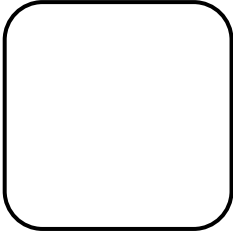

NOTE

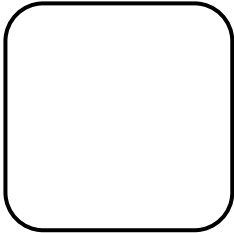

NOTE



**FIELD DEVICES QR CODE**

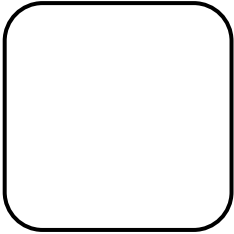

NOTE

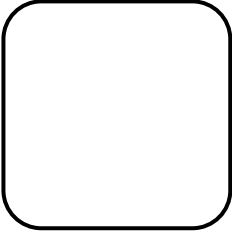

NOTE

**FIELD DEVICES QR CODE**

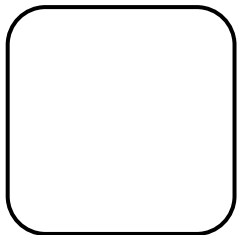

NOTE

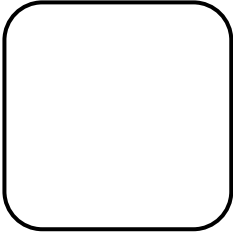

NOTE

**FIELD DEVICES QR CODE**

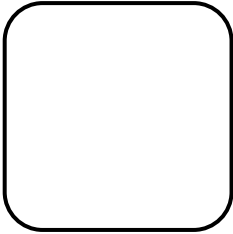

NOTE

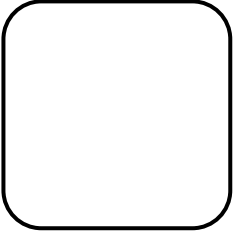

NOTE

**FIELD DEVICES QR CODE**

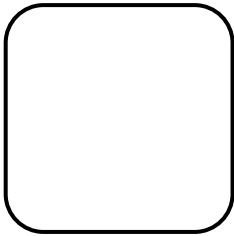

NOTE

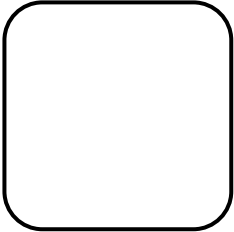

NOTE

**FIELD DEVICES QR CODE**

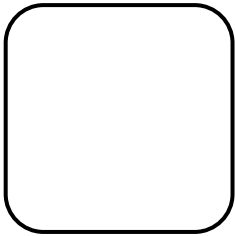

NOTE

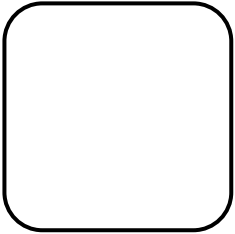

NOTE

**FIELD DEVICES QR CODE**

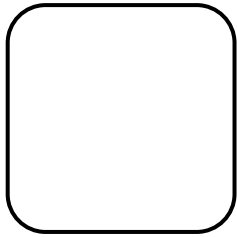

NOTE

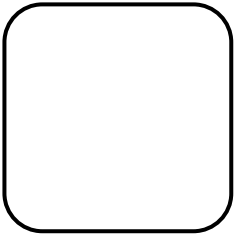

NOTE

**FIELD DEVICES QR CODE**

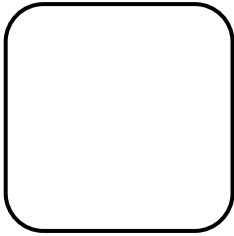

NOTE

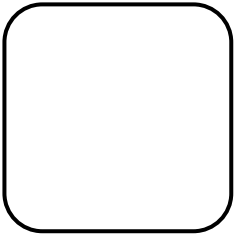

NOTE

**FIELD DEVICES QR CODE**

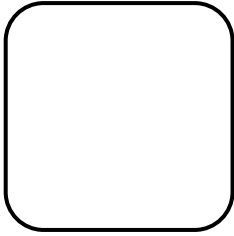

NOTE

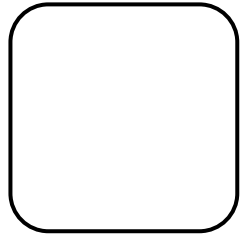

NOTE



**FIELD DEVICES QR CODE**

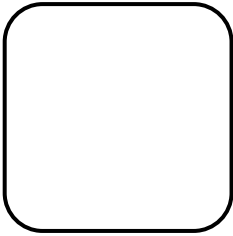

NOTE

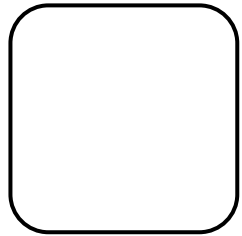

NOTE

**FIELD DEVICES QR CODE**

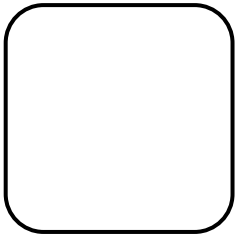

NOTE

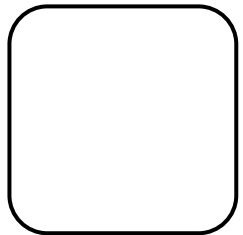

NOTE

**FIELD DEVICES QR CODE**

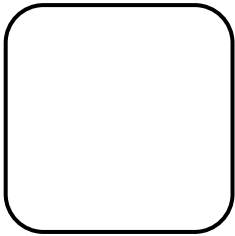

NOTE

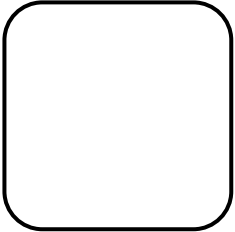

NOTE

**FIELD DEVICES QR CODE**

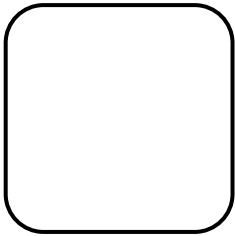

NOTE

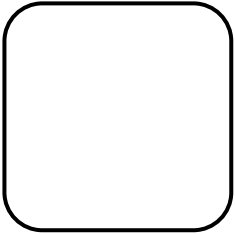

NOTE

**FIELD DEVICES QR CODE**

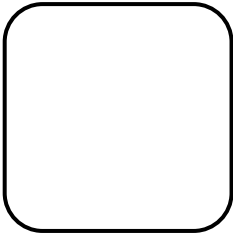

NOTE

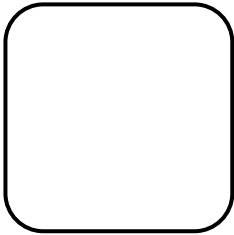

NOTE

**FIELD DEVICES QR CODE**

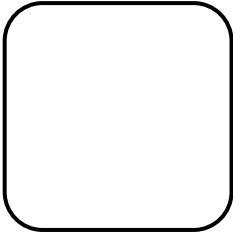

NOTE

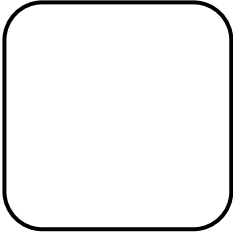

NOTE

**FIELD DEVICES QR CODE**

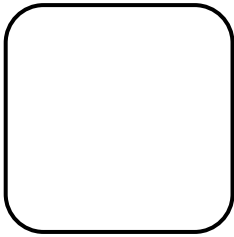

NOTE

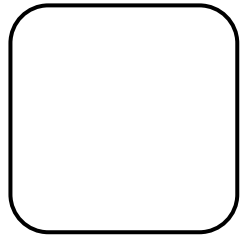

NOTE