

Natron Test Kit

Wireless survey kit for preliminary testing of the radio range and the signal quality of Natron wireless system

TELETEK

Teletek Electronics JSC
Address: 2 Iliyansko Shose Str,
1220 Sofia, Bulgaria

NOTE: Read carefully this Installation Instructions before starting operation with the test kit! This manual is subject to change without notice!

ATTENTION!

Natron Test Kit is designed and operates according to the international standards required to meet the mandatory requirements of Radio Equipment Directive (RED).

IMPORTANT NOTES BEFORE STARTING THE TEST

- Natron Test Device (the probe) is enrolled to the test panel Natron-T by the manufacturer during the final assembly of the test kit.
- The default set radio frequency channel for test is "Channel 0". There are 6 pairs of available frequency channels for performing test. If a several Natron systems are expected to operate at a single site it is obligatory to set their operation at different frequency channels.
- Make complete site survey for presence of other wireless systems/devices emitting radio signals at 868MHz operating frequency! If there are other systems/devices operating on 868MHz they can disturb the proper operation of the whole Natron system.
- Perform the preliminary test using Natron Test Kit while all present wireless systems/devices on the site are turn on and emit signals according their operation functionality. During the test all doors and windows at the site must be closed.
- Check the local regulations, standards, and work practices for installation of wireless systems/devices – they may vary from country to country and you must consider them before starting the installation of Natron wireless system.

1. General Description

Natron Test Kit is a survey test equipment for providing preliminary radio frequency test at the protection site, where Natron Wireless Fire System is planned to be installed. The kit is delivered in a portable plastic suitcase with comfortable handle and option for locking the both double throw latches. The testing equipment is well protected in a customized foam inserts into the suitcase.

Natron-T is a test panel. It is mounted in a compact plastic enclosure box. The information for the radio test and determined quality of the radio signal is presented on an LCD text display. A dipole SMA type antenna is supplied with the equipment to ensure wide covering range of the test panel and stable communication with the Natron testing device during the test procedure. During the test the Natron-T must be placed at the chosen place for the Natron WE-x wireless expander or Natron WR wireless repeater.

The testing device (probe) is equipped with a special conduit-box joint for connection to the provided extension tubes. The purpose of the probe is to imitate operation of the wireless Natron device at the chosen place for mounting, and thus to test the quality of the radio signal between the device and the test panel.

Natron Test Kit complies to EN 54-25.

2. Functional Features

Natron-T test panel

- Versatile power supply according to the conditions of the site – adapter or batteries
- LCD display for reviewing the signal quality and strength with the test device
- Dipole antenna, SMA connector type

Natron Test Device

- Enrolled to the test panel by default, no need of further settings
- One man walk test procedure – only one person can provide the entire test
- Clear sound and visual signals for starting and ending the radio test
- Easy operation with one hand

3. Technical Specifications

3.1. Common Test System

Radio frequency	868MHz
Communication type	Bidirectional
Communication protocol	NATRON TTE
Radio signal modulation type	GFSK
Number of frequency channels	6 pair channels
Radiated power	≤ 25 mW
Receiver category (EN300-220-1)	1.5
Communication range between Natron-T and Natron test device	1500m (open space)
Trace attenuation	> -90dBm
Operation temperature	-10°C to +55°C
Related humidity resistance (no condensation)	(93±3)%@ 40°C
Use	Indoor

3.2. Natron-T test panel

Power supply	AC/DC adapter	Input: 100-240V AC; 50/60Hz; 0.6A Output: 15V DC; 15W
	Batteries	5 x CR123A, 3V
Consumption	<50mA	
Dipole antenna:	<ul style="list-style-type: none"> - Frequency - Impedance - Type of Radiation - Gain - Connector type - Dimensions 	
	866-870MHz, Center 868Mhz 50Ω Omni-directional 2 dBi SMA Male (Swivel) 242x12.5mm	
Dimensions	191x125x61mm	
Weight (with batteries and mounted antenna)	520g	

3.3. Natron Test Device (probe)

Battery power supply	2 x CR123A, 3V
Built-in buzzer volume	80dB/1m
Dimensions	Ø106x113mm
Weight (with batteries)	240g

4. Kit Contents

Natron Test Kit Suitcase

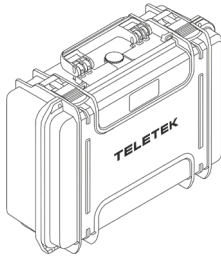

- Dimensions: 464x176x366mm
- Weight (with test equipment): 4.13kg
- Material: PPC (Polypropylene copolymer)
- Colour: Black

Kit Contents

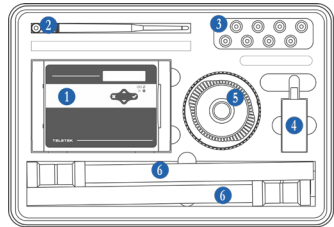

- 1 - Natron-T Test panel
- 2 - Dipole SMA antenna
- 3 - 8 x CR123A battery, 3V
- 4 - AC/DC Power adapter, 15VDC/1A, 15W
- 5 - Natron Test Device
- 6 - 2 x Extension tubes with PVC couplings, 1 x Extension tube with control test button

Natron-T

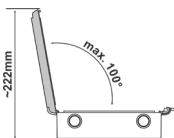
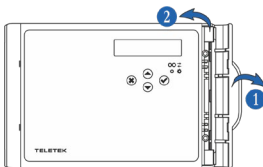

Attention: The max. angle of cover opening is 100°!

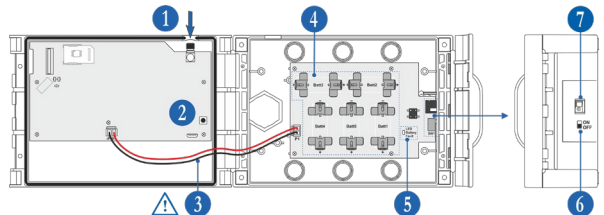

- 1 - Opening for mounting of the antenna
- 2 - Programming button
- 3 - Power cable, ~220mm
- 4 - Batteries compartment
- 5 - Status red LED for batteries fault condition (lights on in case of reversed polarity of one or several batteries)
- 6 - ON/OFF Switch
- 7 - Power adapter connector

Natron Test Device

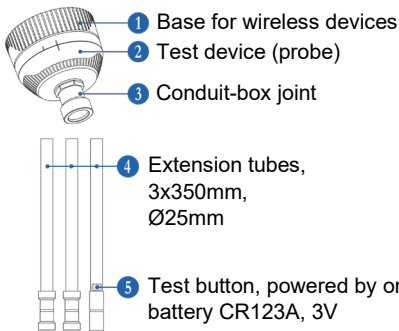

- 1 - Base for wireless devices
- 2 - Test device (probe)
- 3 - Conduit-box joint

- 4 - Extension tubes, 3x350mm, Ø25mm

- 5 - Test button, powered by one battery CR123A, 3V

Positioning of the antenna

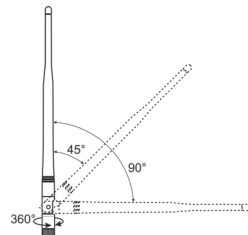

For achieving the best signal strength and coverage it is recommended the antenna to be mounted in straight up position!

The antenna's body can be bent at position of 45° and 90° and is providing continuous rotation on 360° at its base.

5. Preparation for Test

Attention: Make complete site survey for presence of other wireless systems/devices emitting radio signals at 868MHz operating frequency! Other systems/devices operating at 868MHz can disturb the proper operation of the whole Natron system.

- Before planning the test, obtain on paper the site diagram of the planned Natron wireless system.
- Go around the site and inspect the preliminary places for mounting of the wireless devices. If there are additional obstacles or other structures not in the plan, draw them on the diagram too.
- The installation of Natron wireless devices must be away from power lines, high voltage equipment with large electric consumption, fluorescent lamps and lighting fixtures, Wi/Fi routers, wireless telephone stations, computer, and network cablings.
- Big metal structures – cabinets, pending ceilings, thick concrete walls can seriously reduce the radio signal. *Note that, the quality of the signal strength is reduced with 80%, and sometimes with 100% (full reflection) in premises with metal walls or surfaces.*

Test Diagram

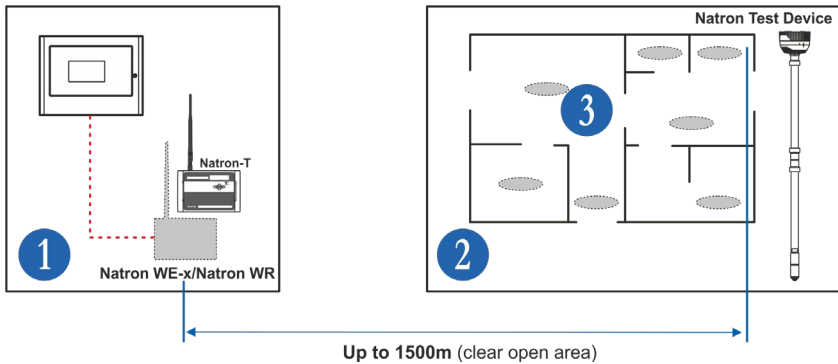

1 - Protected site with built hardware fire alarm system (addressable iRIS4/iRIS8/SIMPO panel; conventional MAG 2/4/8/8Plus or other). Place the Natron-T test panel at the place selected for installation of the wireless expander Natron WE-x or Natron WR repeater panel.

2 - New site planned for installation of Natron wireless fire alarm system.

3 - Preliminary selected places for mounting of Natron wireless devices – points for test with the Natron test device (probe).

Positioning the Natron Test Device

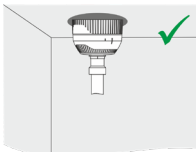

Correct positioning of the Natron test device. The base of the probe must be fitted at the exact place for installation of the wireless device and to touch the mounting surface.

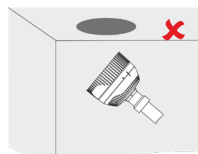
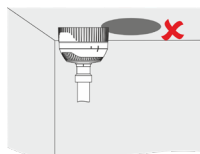
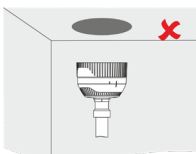

Not correct positioning of the Natron test device.

Extension Tubes

Included in the Natron Test Kit extension tubes are designed for joining to each other ensuring to reach heights up to 1200mm. **It is forbidden to cut the tubes or to add new to the maximum configuration!** For higher places, where the maximum length of the extension tubes is not enough, use a ladder or a platform to step to reach the selected place of installation.

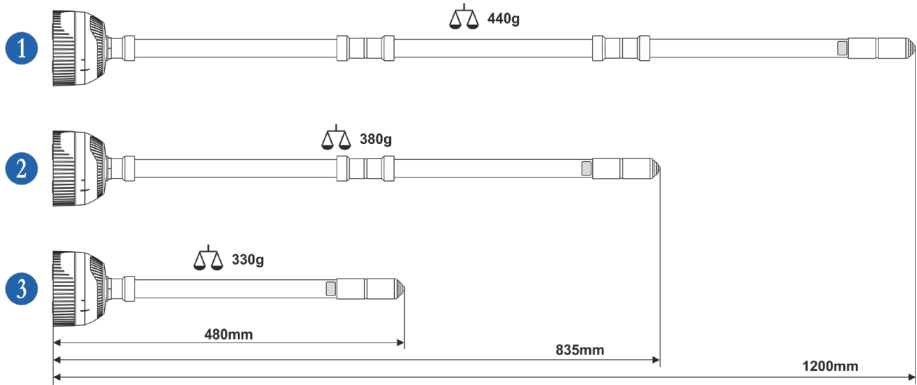

Power On the Natron Test Device

You must use 2 pcs from the supplied batteries to power on the probe test device and 1 pc to power on the test button.

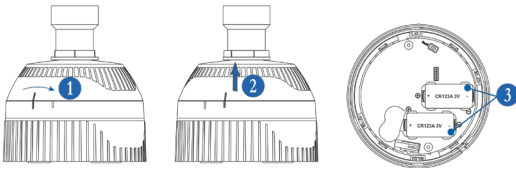

To power on the test device, dismount the base from the probe and place the batteries as observing the polarity. Mount back the base to the test device.

The probe is factory enrolled to the test panel and is ready to start tests.

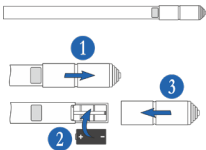

To power on the test button, dismount the handle from the extension tube and place a battery as observing the polarity. Then put back the handle in place covering the battery compartment.

6. Channel Setup

Natron series wireless devices communicate with the expander (network gateway) module via 6 different frequency pair channels. The installer can test operation via specific channel pair from 0 to 5. Performing separate tests, the installer can assess which channel has the lowest noise and interference level and to program it for operation of the Natron wireless system.

Note: When in a protected site are planned to operate more than one expander (network gateway) modules, they must be tested at different frequency channel numbers.

To set a frequency channel, power on the Natron-T and press the programming button on the main board – see item 5. Use the up/down arrow buttons to scroll to menu 3. CHANNEL SETUP. Press ENTER button. Using the arrow buttons, scroll to a number of pair channels. The current displayed setting on the screen is selected for test.

7. Testing Procedure

The testing procedure for obtaining the quality of the radio signal is quite easy and can be done from one person. The result of the provided test is displayed on the screen of the test panel, and is presented via sound and LED indication from the test device (probe).

1. Position the Natron-T test panel at the exact place selected for installation of Natron WE-x wireless expander module/Natron WR wireless repeater. Open the front cover and mount the antenna to the main PCB. To guarantee a stable and an uninterrupted power supply during the test, it is recommended to use both options for power supply at the same time – batteries and adapter connected to the mains. **Note:** *In case of mains power supply failure, the batteries power supply will switch on automatically; when the mains power supply is restored, the batteries power supply will be switched off automatically.*
2. Turn on the power of Natron-T via the ON/OFF button on the right-handed side of the box. The screen displays “Wireless Test Equipment”. At this step you must select a radio channel for test – see item 6. By default, radio channel “0” is set for running test.
3. Power on the test device (probe) and the test button - see item 5. Mount the probe to the extension tubes. Take the test device and the drawing of the planned Natron wireless system and go to the project site.
4. Following the instructions for correct positioning of the probe, place it on the first preliminary selected place for installation of a wireless device – the bottom of the probe must touch the mounting surface.
5. Press the test button. The start of the test is announced with a single short sound signal and the LEDs of the probe are lighting on in green. Wait 7-8 seconds the test to complete as holding still and without moving the testing device.
6. The end of the test is announced with a second single short sound signal followed by slow flashing LED indication for the quality of the radio signal:

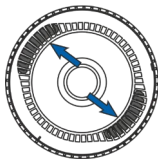

- 3 flashes in green – very good* signal strength;
- 3 flashes in orange – average good* signal strength; but, if possible, change the preliminary selected place and do the test again;
- 3 flashes in red – poor* signal strength; it is obligatory to change the preliminary selected place and do the test again.

***Note:** *The quality of the signal is also displayed on the screen of the Natron-T test panel.*

7. Write down the result on the site diagram.
8. Ensure minimum 15 seconds between two consecutive tests.
9. Proceed the test at the next selected place for installation of a wireless device.
10. After completing the whole test, remove the batteries from the test panel, test device and the test button.
11. Put the testing equipment back into the suitcase and keep in a safe place away from water, moisture, and dust.

8. Batteries Maintenance

The batteries' life /the discharging rate/ depends on the frequency of using the test equipment and the duration of the provided tests. It is recommended to check the batteries capacity of the test device and the test button periodically to ensure correct measurement of the quality of the radio signals. Always use only batteries approved by the manufacturer - Panasonic CR123A 3V or other with similar characteristics.

CAUTION: *Do not expose used batteries to fire, hot ovens, or mechanical crushing/cutting as this can result in an explosion. Exposing batteries to extremely high environmental temperatures or low air pressure can result in explosion or the leakage of flammable liquid or gas.*

DISPOSAL: *Follow local regulations regarding disposal of the batteries.*